

## Toyota Yaris 3 / 5 Drs 2006-

Partnr.: TO-138-BB

**DE** Einbauanleitung Elektrosatz Anhänger-Vorrichtung mit 12-N Steckdose lt. DIN/ISO Norm 1724.

**FR** Instructions de montage du faisceau électrique pour crochet d'attelage conforme à la norme DIN/ISO 1724 prise 12-V

**NL** Montage-handleiding elektrokabelset voor trekhaak met 12-N contactdoos vlg. DIN/ISO norm 1724.

**GB** Fitting instructions electric wiring kit tow bar with 12-N socket up to DIN/ISO Norm 1724.

**ES** Instrucciones de montaje de kit eléctrico para enganche de remolque con caja de conexiones 12-N según norma DIN/ISO 1724.

**IT** Istruzioni di montaggio di set di cavi elettrici per gancio da traino con zoccolo a 12 N conforme alla norma DIN/ISO 1724.

**SE** Monteringsanvisningar elkabelsats för dragkrok med 12-N kontaktdosa enligt DIN/ISO norm 1724.

**CZ** Montážní pokyny: souprava pro elektrické propojení tažné tyče s 12 - N zásuvkou do normy DIN/ISO 1724.

**DK** Monteringsvejledninger for det elektriske ledningsføringssæt for trækstang med 12-N stikdåse, DIN/ISO, norm 1724.

**FI** Ohjeet vetokoukun sähkökaapelisarjan asentamiseen, jossa on DIN/ISO 1724 mukainen 12-N liitin.

**GR** Οδηγίες συναρμολόγησης ηλεκτρικού σετ καλωδίων μπάρας ρυμούλκησης με υποδοχή 12-N μέχρι DIN/ISO Κανόνας 1724.

**NO** Monteringsanviser elkabelsett for trekrok med 12-N koblingsboks ifølge DIN/ISO norm 1724.

**PL** Instrukcje montażu zestawu okablowania elektrycznego dyszla holowniczego z 12-N stykowym gniazdem DIN/ISO 1724.

**DE** - Wir weisen ausdrücklich darauf hin, dass eine unsachgemäße und nicht in einer Fachwerkstatt durchgeführte Montage einen Verzicht auf Entschädigung jeglicher Art insbesondere bezüglich des Produkthaftpflichtrechts zur Folge hat.

**FR** - Il est expressément prévu qu' on ne saurait se prévaloir d'un quelconque préjudice contractuel ou rédhibitoire si le montage avait été fait en dépit des dites instructions ou dans un garage ne disposant pas des équipements adéquats.

**NL** - Wij wijzen er met nadruk op, dat ondeskundige en niet door een vakkundige werkplaats uitgevoerde montage tot gevolg heeft dat daardoor ieder recht op schadevergoeding, ook op wettelijke aansprakelijkheid inzake producten, vervalt.

**GB** - We would expressly point out that assembly not carried out properly by a competent installer will result in cancellation of any right to damage compensation, in particular those arising by virtue of the product liability act.

**ES** - El montaje inapropiado y efectuado por personal no cualificado originará la pérdida de todo derecho a indemnización o la expiración de toda responsabilidad civil con respecto al producto.

**IT** - Sottolineiamo espressamente che un montaggio inadeguato ed eseguito da un'officina non specializzata ha come conseguenza il decadere di qualsiasi diritto al risarcimento danni, nonché alla responsabilità legale relativa ai prodotti.

**SE** - Vi påpekar med eftertryck att all rätt till skadeersättning och all laglig ansvarighet förfaller om monteringen inte har utförts på rätt sätt och av en professionell verkstad.

**CZ** - Výslovně zdůrazňujeme, že jakákoli montáž, která není provedená ve specializované dílně, má za následek odvolání nároků na kompenzaci jakéhokoli druhu, obzvláště vyplývajících ze zákona o odpovědnosti za způsobené škody.

**DK** - Vi ønsker at gøre udtrykkeligt opmærksom på at forkert samling, der ikke er udført af et specialiseret værksted, resulterer i bortfaldelse af kompenseringskrav af alle slags, i særdeles krav der måtte opstå omkring det lovpligtige ansvar.

**FI** - Korostamme, että kaikki oikeudet vahinkokorvaukseen kuten myös valmistajan laillinen vastuu raukeavat, mikäli asennusta ei ole toteutettu oikealla tavalla eikä ammattitaitoisen asiantuntijan toimesta.

**GR** - Επισημαίνουμε κατηγορηματικά ότι οποιαδήποτε εσφαλμένη συναρμολόγηση, η οποία δεν έχει πραγματοποιηθεί ειδικό εργαστήριο θα οδηγήσει σε απονοίηση των αξιώσεων επιβολής αποζημιώσεων οποιαδήποτε είδους, ειδικά όσα προκύπτουν από το νόμο ευθύνης προϊόντων.

**NO** - Vi påpeker ettertrykkelig at all rett til skadeerstatning og rettslig ansvar forfaller dersom monteringen ikke er blitt utført på riktig måte og av et profesjonelt verksted.

**PL** - Chcielibyśmy wyraźnie zaznaczyć, iż wszelki nieprawidłowy montaż, który nie jest wykonywany w specjalistycznym warsztacie pociąga za sobą utratę możliwości dochodzenia wszelkiego typu roszczeń, w szczególności tych wynikających z odpowiedzialności producenta za swój produkt.

- Technische Änderungen vorbehalten.  
- Widerstand nur gemäß der Tabelle auf dem Anhänger verwenden, siehe Seite 10.

- Sous réserve de modifications techniques.  
- Ne excédez pas la charge maximale, indiquée dans le tableau sur page 10.

- Technische wijzigingen voorbehouden.  
- Gebruik alleen belasting volgens aansluittabel op het getrokken voertuig, zie pagina 10.

- Contents of these kits and their fitting manuals are subject to alteration without notice, please ensure that these instructions are read and fully understood before commencing installation.

- Do not overload circuits; the maximum loads per connection are detailed in this manual.

- Nos reservamos el derecho a efectuar modificaciones técnicas.

- Utilice sólo cargas de acuerdo a la tabla de conexión del vehículo remolcado (ver página 10).

- Ci si riserva il diritto di apportare modifiche tecniche.

- Utilizzare esclusivamente un carico conforme alla tabella degli allacci relativa al veicolo in questione, cfr. pagina 10.

- Tekniska ändringar förbehålles.

- Använd endast belastning enligt anslutningstabellen på det dragna fordonet, se sid. 10.

- Změny mohou být provedeny bez oznámení.

- Používejte pouze při maximálním nabití podle tabulky na tažném vozidle, viz. str. 10.

- Kan ændres uden varsel.

- Brug kun den maksimale belastning, i overensstemmelse med forbindelsestabelen for bugserede køretøjer, side 10.

- Oikeus teknisiin muutoksiin ilman erillistä huomautusta pidätetään.

- Kuormita työvirtapiiriä ainoastaan hinattavan ajoneuvon kytkentäkaavion mukaisesti, katso sivu 10.

- Μπορεί να τροποποιηθεί χωρίς προηγούμενη ειδοποίηση.

- Χρησιμοποιείτε μόνο μέγιστο ηλεκτρικό φορτίο σύμφωνα με τον πίνακα σύνδεσης στο ρυμούλκούμενο όχημα, δείτε σελίδα 10.

- Tekniske endringer forbeholdes. - Overskrid ikke grensene anvist i tilkoblingstabellen på tilhengeren eller det tilkoblede kjøretøyet, se s. 10.

- Podlega zmianom bez powiadomienia.

- Używać tylko takiego maksymalnego obciążenia które wynika z tabliczki połączeń holowanego pojazdu, patrz strona 10.

Einzelteilliste

Liste de pieces

Onderdelenlijst

Part list

Lista de componentes

Elenco componenti

Dellista

Seznam dílů

Del-liste

Osaluettelo

Κατάλογος εξαρτημάτων

Delliste

Lista części

(DE)

(FR)

(NL)

(GB)

(ES)

(IT)

(SE)

(CZ)

(DK)

(FI)

(GR)

(NO)

(PL)

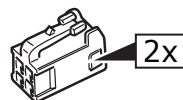
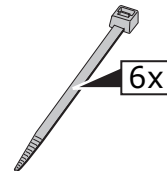
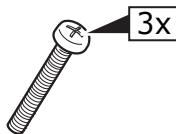
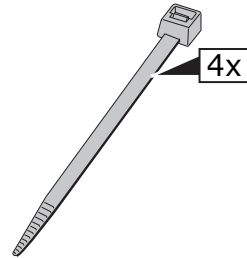
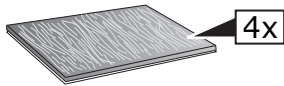
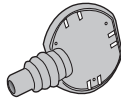
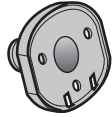
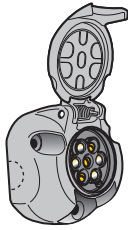
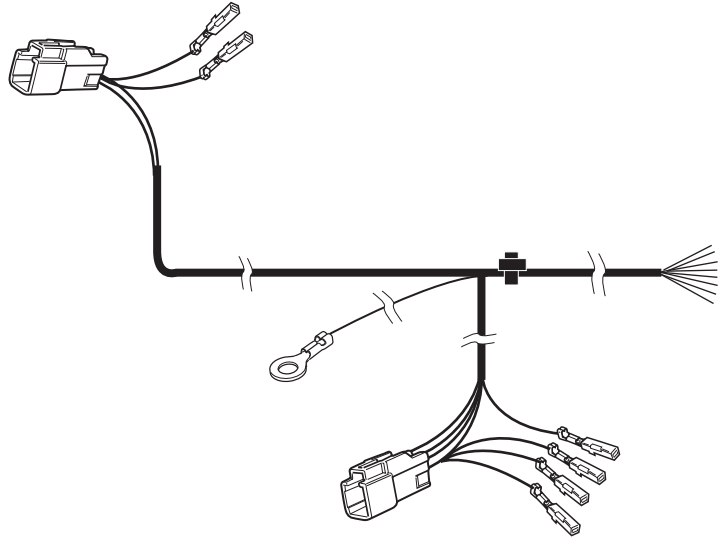
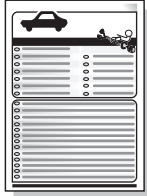
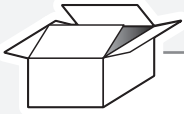

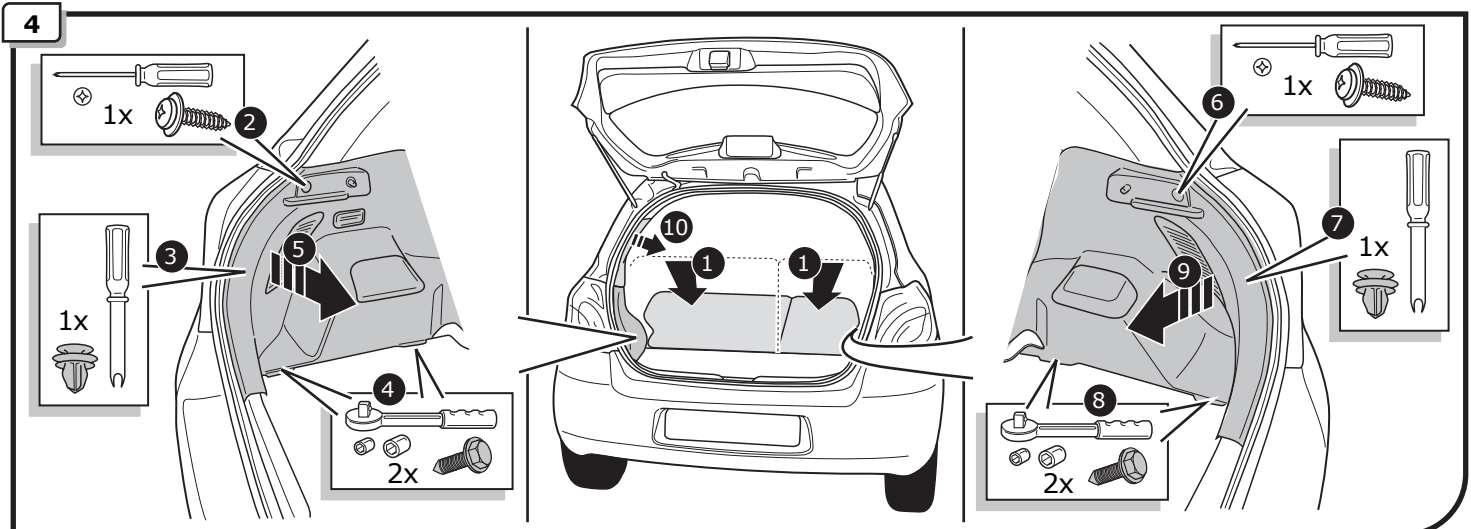
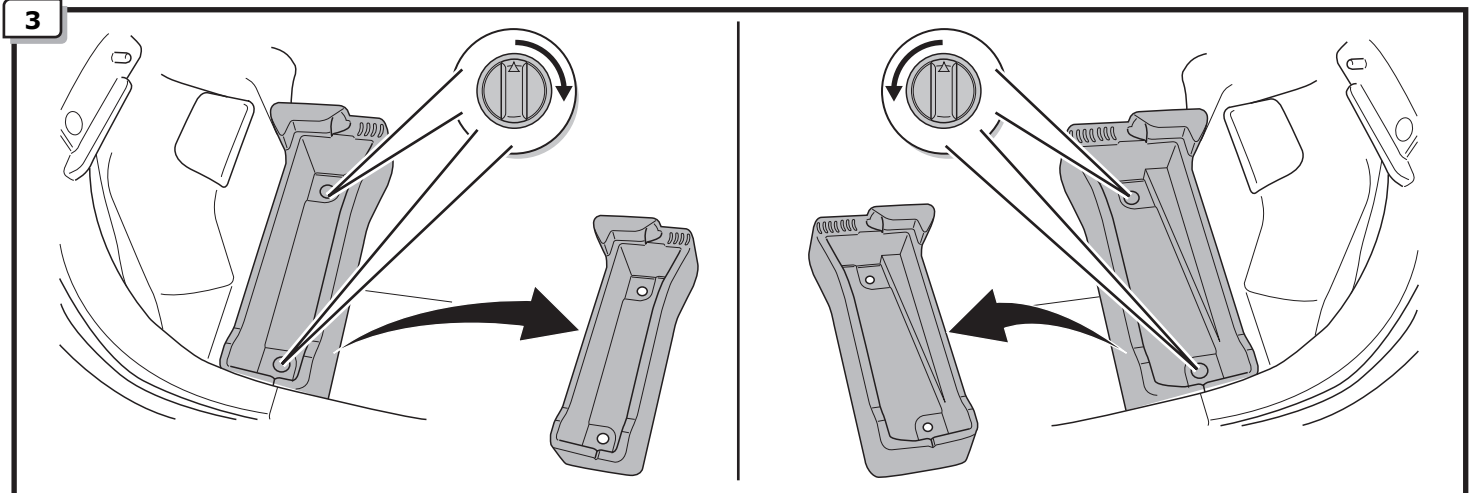
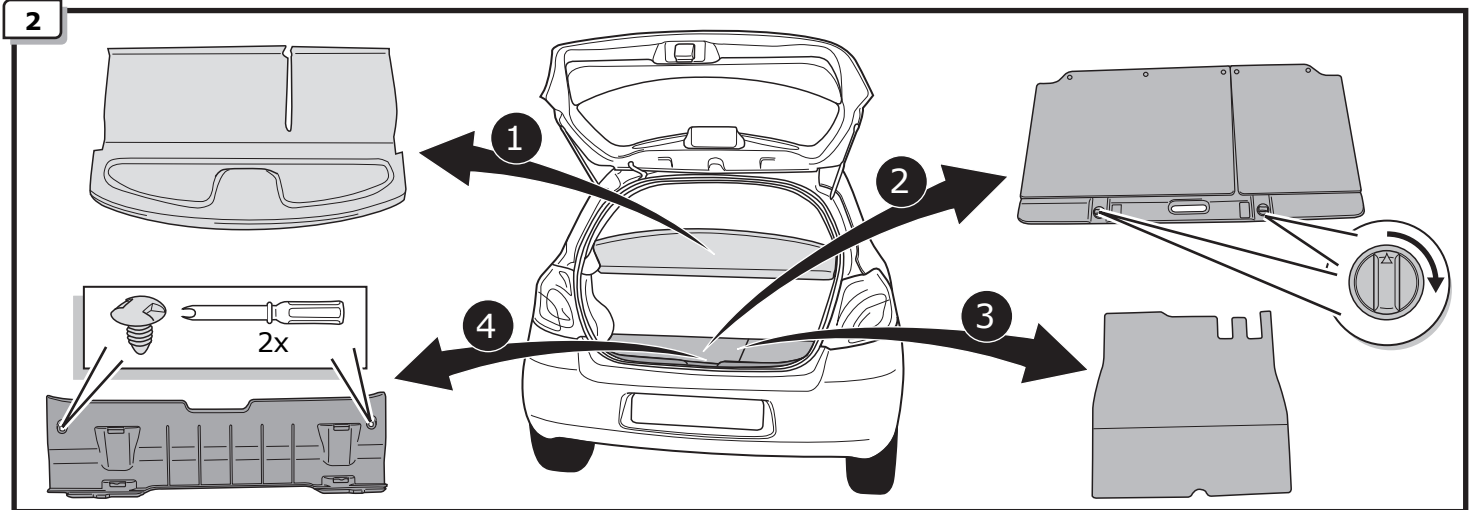
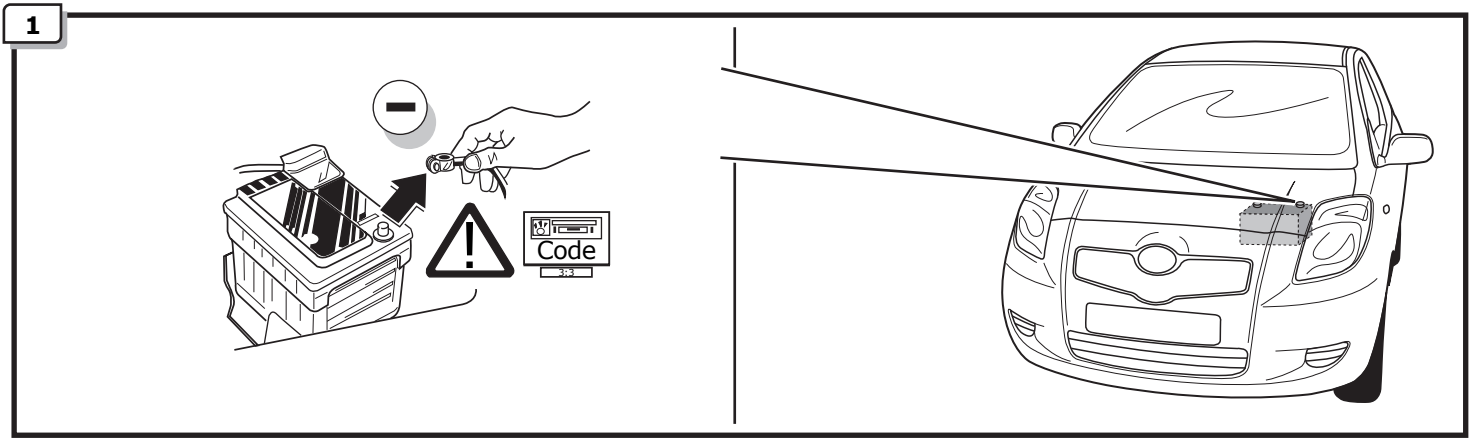

INFO

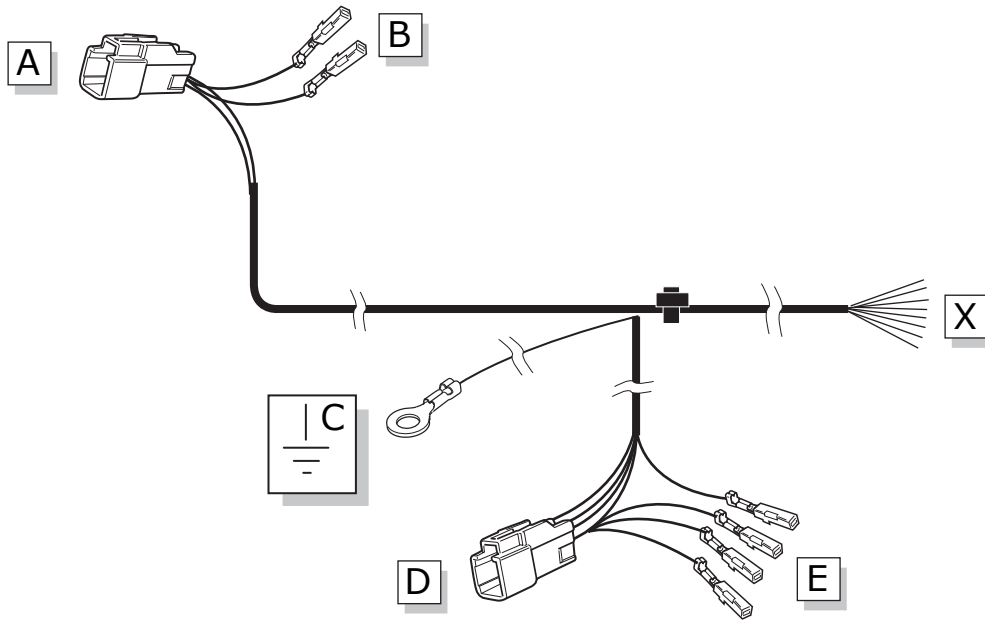

ROUTING

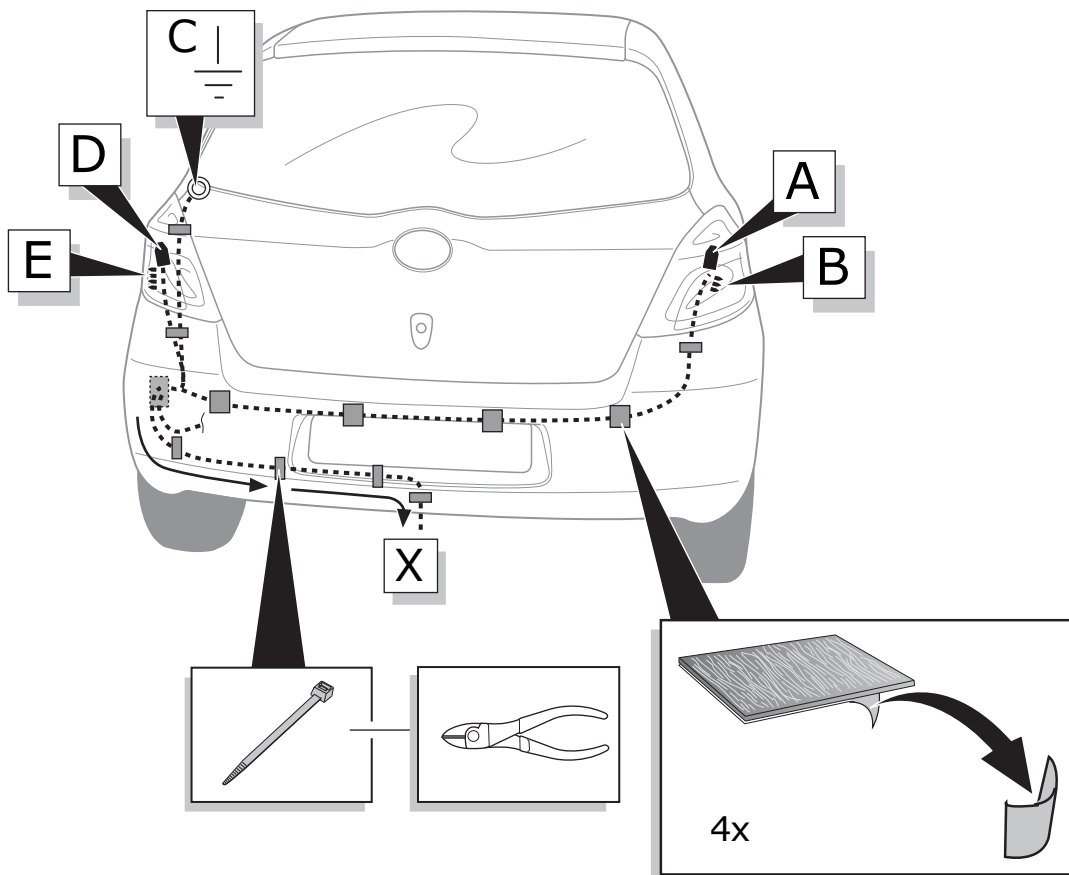

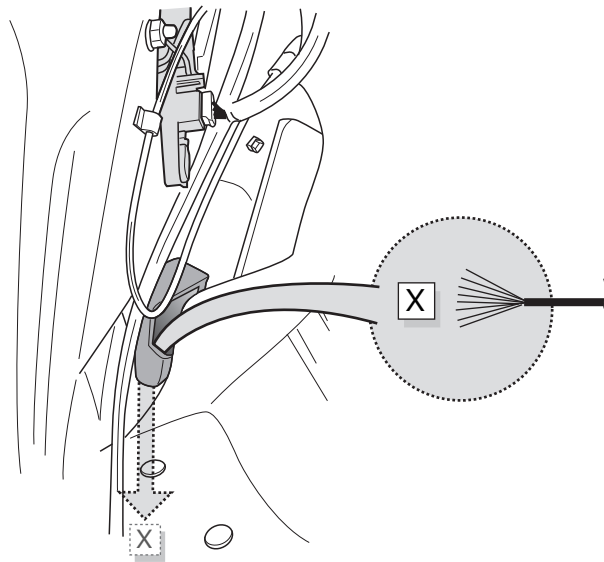
**5****A**

Option 1

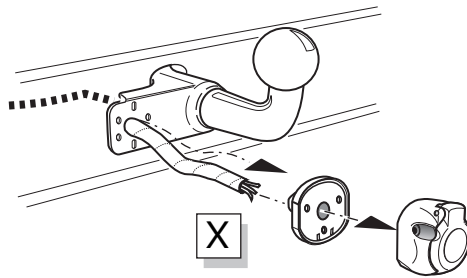

Option 2

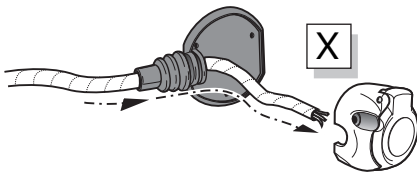

Option 3

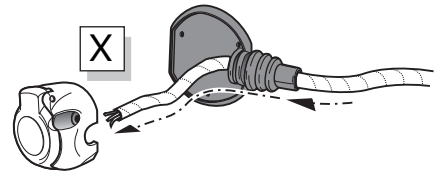
**INFO**

- |                                     |                               |
|-------------------------------------|-------------------------------|
| (DE) Anschluss Steckdose            | (CZ) Objímkový konektor       |
| (FR) Connection de la prise         | (DK) Stikdåse forbindelse     |
| (NL) Contactdoos aansluiting        | (FI) Pistorasia liitäntä      |
| (GB) Socket connection              | (GR) Υποδοχή σύνδεσης         |
| (ES) Conexión de la caja de enchufe | (NO) Tilkobling koblingsboks  |
| (IT) Allaccio zoccolo               | (PL) Połączenie przez gniazdo |
| (SE) Anslutning kontaktdosa         |                               |



Pag. 10

**B**

option 1

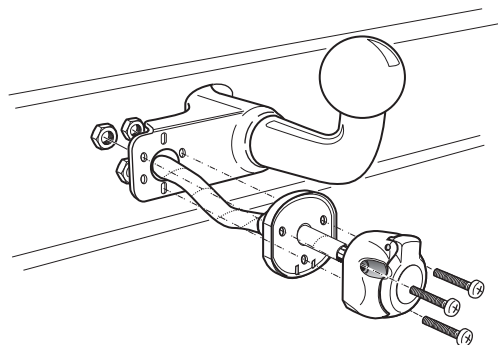

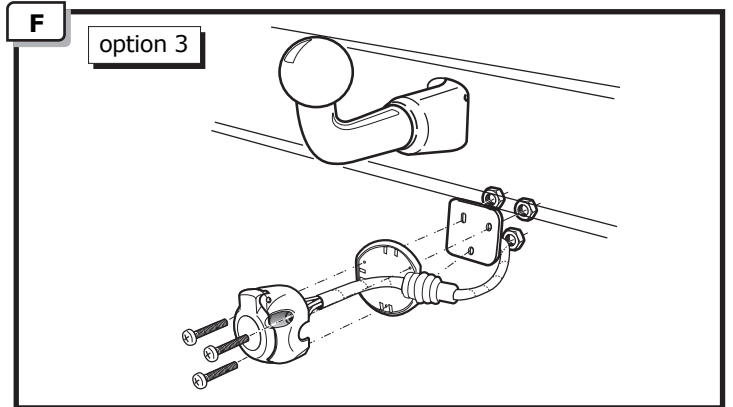
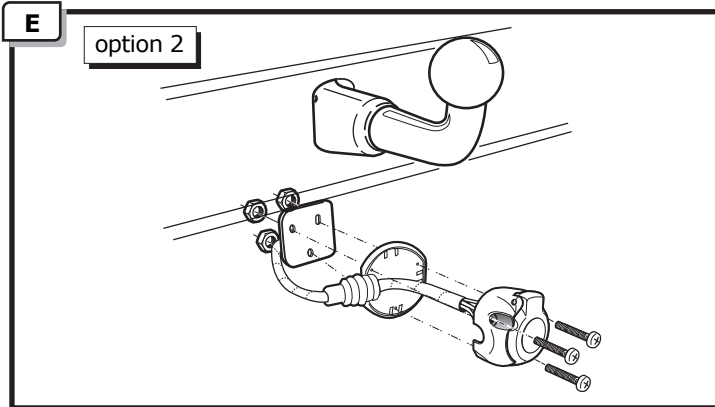
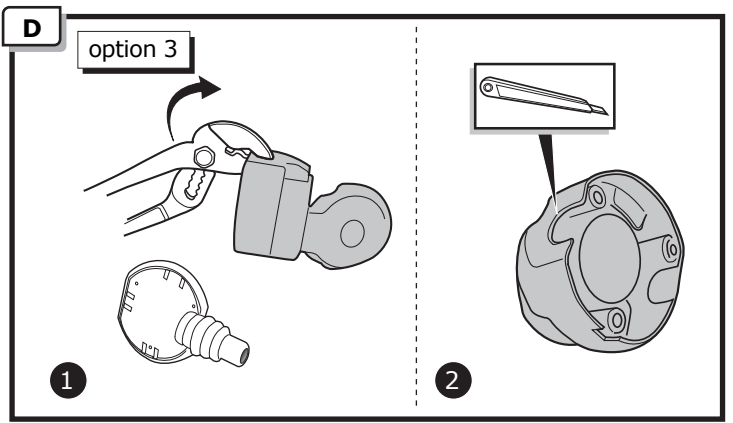
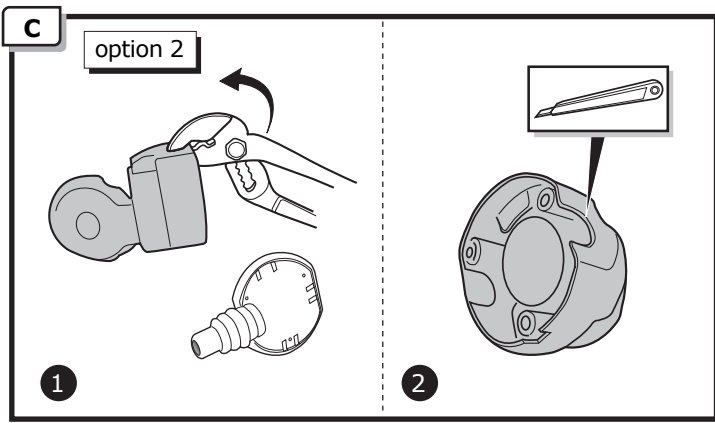

**6**

DE Lokalisieren und überprüfen Sie die Funktionen.  
FR Localisez et vérifiez les fonctions.  
NL Localiseer en meet de functies door.  
ES Locate and check functions.  
ES Localizar y probar funciones.  
IT Verificare le funzioni.  
SE Mätning funktioner.  
CZ Zkontrolujte funkce.  
DK Find og check funktionerne.  
FI Paikanna ja tarkista toiminnot.  
GR Εντονίστε και ελέγξτε τις λειτουργίες.  
NO Lokaliser og mål funksjonene.  
PL Zlokalizuj i sprawdź funkcje.

1

**B** **A**

<p><b>3</b></p> <table border="0"> <tr><td>DE Grün</td><td>CZ Zelená</td></tr> <tr><td>FR Vert</td><td>DK Grøn</td></tr> <tr><td>NL Groen</td><td>FI Vihreä</td></tr> <tr><td>GB Green</td><td>GR Πράσινο</td></tr> <tr><td>ES Verde</td><td>NO Grønn</td></tr> <tr><td>IT Verde</td><td>PL Zielony</td></tr> <tr><td>SE Grön</td><td></td></tr> </table>	DE Grün	CZ Zelená	FR Vert	DK Grøn	NL Groen	FI Vihreä	GB Green	GR Πράσινο	ES Verde	NO Grønn	IT Verde	PL Zielony	SE Grön		<p>→</p> <p>R</p>
DE Grün	CZ Zelená														
FR Vert	DK Grøn														
NL Groen	FI Vihreä														
GB Green	GR Πράσινο														
ES Verde	NO Grønn														
IT Verde	PL Zielony														
SE Grön															

**2**

<table border="0"> <tr><td>DE Gelb</td><td>CZ Žlutá</td></tr> <tr><td>FR Jaune</td><td>DK Gul</td></tr> <tr><td>NL Geel</td><td>FI Keltainen</td></tr> <tr><td>ES Yellow</td><td>GR Κίτρινο</td></tr> <tr><td>GB Amarillo</td><td>NO Gul</td></tr> <tr><td>IT Giallo</td><td>PL Żółty</td></tr> <tr><td>SE Gul</td><td></td></tr> </table>	DE Gelb	CZ Žlutá	FR Jaune	DK Gul	NL Geel	FI Keltainen	ES Yellow	GR Κίτρινο	GB Amarillo	NO Gul	IT Giallo	PL Żółty	SE Gul		<p>→</p> <p>R</p>
DE Gelb	CZ Žlutá														
FR Jaune	DK Gul														
NL Geel	FI Keltainen														
ES Yellow	GR Κίτρινο														
GB Amarillo	NO Gul														
IT Giallo	PL Żółty														
SE Gul															

**4**

<table border="0"> <tr><td>DE Grau</td><td>CZ Šedá</td></tr> <tr><td>FR Gris</td><td>DK Grå</td></tr> <tr><td>NL Grijs</td><td>FI Harmaa</td></tr> <tr><td>GB Grey</td><td>GR Γκρι</td></tr> <tr><td>ES Gris</td><td>NO Grå</td></tr> <tr><td>IT Grigio</td><td>PL Szary</td></tr> <tr><td>SE Grå</td><td></td></tr> </table>	DE Grau	CZ Šedá	FR Gris	DK Grå	NL Grijs	FI Harmaa	GB Grey	GR Γκρι	ES Gris	NO Grå	IT Grigio	PL Szary	SE Grå		<p>☀</p> <p>58-R</p>
DE Grau	CZ Šedá														
FR Gris	DK Grå														
NL Grijs	FI Harmaa														
GB Grey	GR Γκρι														
ES Gris	NO Grå														
IT Grigio	PL Szary														
SE Grå															

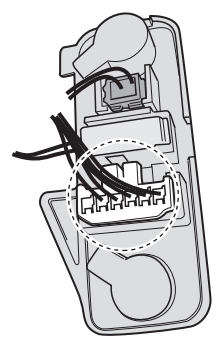
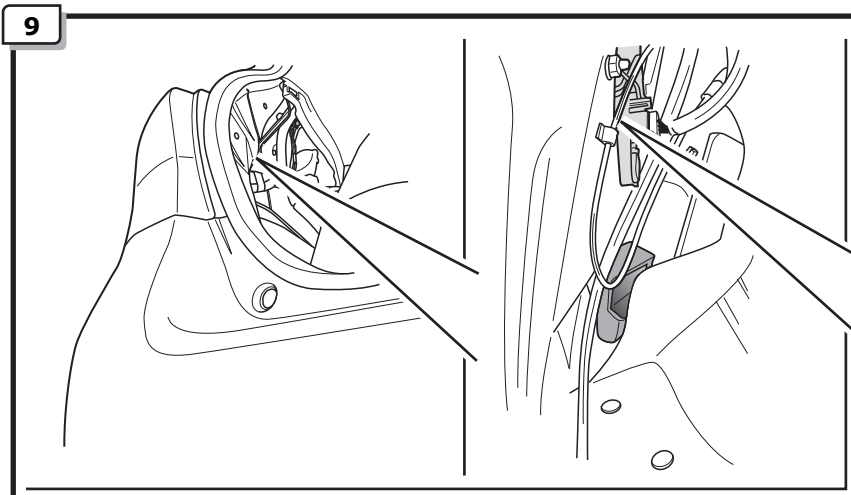
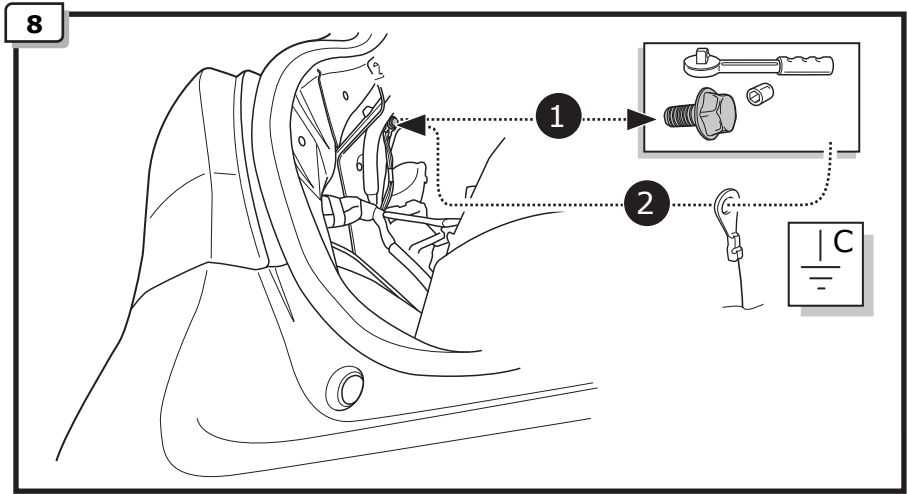
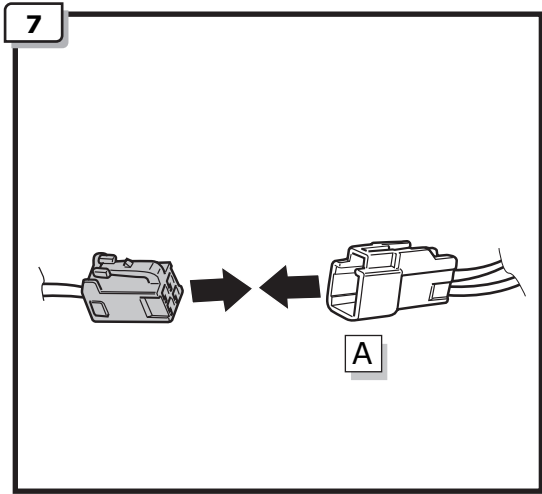

- DE Lokalisieren und überprüfen Sie die Funktionen.
  - FR Localisez et vérifiez les fonctions.
  - NL Lokaliseer en meet de functies door.
  - GB Locate and check functions.
  - ES Localizar y probar funciones.
  - IT Verificare le funzioni.
  - SE Mätning funktioner.
  - CZ Zkontrolujte funkce.
  - DK Find og check funktionerne.
  - FI Paikanna ja tarkista toiminnot.
  - GR Εντονίστε και ελέγξτε τις λειτουργίες.
  - NO Lokaliser og mål funksjonene.
  - PL Zlokalizuj i sprawdź funkcje.
- 1**
- 

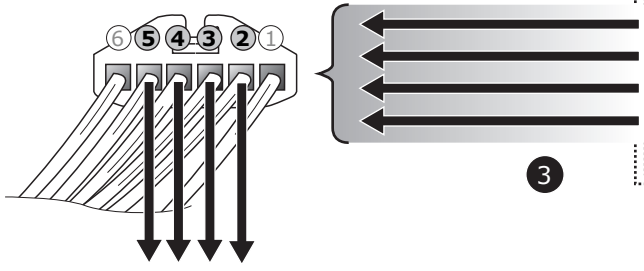
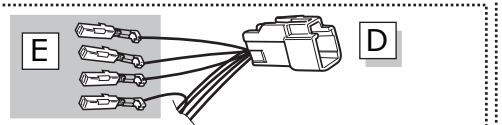

DE	Grau	CZ	Šedá	54-G
FR	Gris	DK	Grå	
NL	Grijs	FI	Harmaa	54-G
GB	Grey	GR	Γκρι	
ES	Gris	NO	Grå	54-G
IT	Grigio	PL	Szary	
SE	Grå			

DE	Gelb	CZ	Žlutá	L
FR	Jaune	DK	Gul	
NL	Geel	FI	Keltainen	L
GB	Yellow	GR	Κίτρινο	
ES	Amarillo	NO	Gul	L
IT	Giallo	PL	Żółty	
SE	Gul			

DE	Schwarz	CZ	Černá	58-L
FR	Noir	DK	Sort	
NL	Zwart	FI	Musta	58-L
GB	Black	GR	Μαύρο	
ES	Negro	NO	Svart	58-L
IT	Nero	PL	Czarny	
SE	Svart			

DE	Rot	CZ	Červená	STOP
FR	Rouge	DK	Rød	
NL	Rood	FI	Punainen	STOP
GB	Red	GR	Κόκκινο	
ES	Rojo	NO	Rød	54
IT	Rosso	PL	Czerwony	
SE	Röd			

DE	Purper	CZ	Purpurov	STOP
FR	Pourpre	DK	Purper	
NL	Paars	FI	Purppura	STOP
GB	Purple	GR	Πορφυρό	
ES	Púrpura	NO	Purper	54
IT	Rosso porpora	PL	Purpurowa	
SE	Purper			

DE	Hellblau	CZ	Bleděmodrá	L
FR	Bleu clair	DK	Lyseblå	
NL	Lichtblauw	FI	Vaaleansininen	L
GB	Light blue	GR	Ανοιχτό μπλε	
ES	Azul claro	NO	Lyseblå	L
IT	Blu chiaro	PL	Jasnoniebieska	
SE	Ljusblå			

DE	Grün	CZ	Zelená	58-L
FR	Vert	DK	Grøn	
NL	Groen	FI	Vihreä	58-L
GB	Green	GR	Πράσινο	
ES	Verde	NO	Grønn	58-L
IT	Verde	PL	Zielony	
SE	Grön			

DE	Dunkelblau	CZ	Tmavomodrá	54-G
FR	Bleu foncé	DK	Mørkeblå	
NL	Donkerblauw	FI	Tummansininen	54-G
GB	Dark blue	GR	Σκούρο μπλε	
ES	Azul oscuro	NO	Mørkeblå	54-G
IT	Blu scuro	PL	Granatowa	
SE	Mørkeblå			

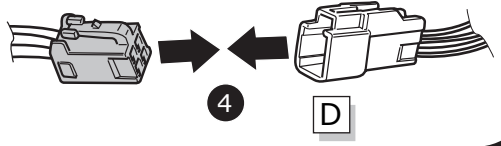

10

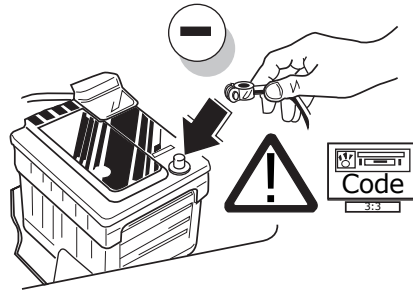

11

- DE** FUNKTIONEN KONTROLLIEREN MIT EINEM PRÜFGERÄT MIT WIDERSTAND ODER MIT LEUCHTEN MIT DER GENAUEN WATTZAHL!
- FR** CONTRÔLER LES FONCTIONS AVEC UNE BOÎTE DE TEST AVEC DE LA CHARGE OU DES LAMPES AVEC LA QUANTITÉ CORRECTE DE WATT!
- NL** CONTROLEER FUNCTIES MET EEN TESTER MET BELASTING OF LAMPEN MET DE JUISTE WATTAGE!
- GB** TEST ALL CIRCUIT FUNCTIONS WITH A TESTBOX WITH THE CORRECT POWER LOAD FOR EACH UNIT. A TESTBOX ON WHICH ONLY LEDs ARE USED CAN NOT BE USED IN THIS CASE
- ES** ¡CONTROLAR FUNCIONES CON UN TESTER CON CARGA O LUCES CON EL CORRECTO WATTAJE!
- IT** CONTROLLA FUNZIONI CON UN TESTER CON CARICO O LAMPADE DEL GIUSTO WATT-TAGGIO!
- SE** KONTROLLERA FUNKTIONERNA MED EN TESTARE MED BELASTNING ELLER LAMPOR MED RÄTT WATT-VÄRDE!
- CZ** OVĚŘTE FUNKCE POMOCÍ TESTOVACÍHO BOXU NEBO SVĚTEL S PŘÍSLUŠNÝM VÝKONEM!
- DK** CHECK FUNKTIONERNE MED EN TESTBOKS, MED BELASTNING ELLER MED LYGTER MED DET KORREKTE ANTAL WATT!
- FI** TARKISTA TOIMINNOT KÄYTTÄMÄLLÄ TESTILAITE, JOSSA ON OIKEATEHOINEN KUORMITUS TAI OIKEATEHOISET LAMPUT!
- GR** ΕΛΕΓΕΤΕ ΤΙΣ ΛΕΙΤΟΥΡΓΙΕΣ ΜΕ ΈΝΑ ΚΙΒΩΤΙΟ ΔΟΚΙΜΗΣ ΜΕ ΦΟΡΤΙΟ Ή ΛΑΜΠΗΡΕΣ ΣΩΣΤΗΣ ΠΟΣΟΤΗΤΑΣ ΒΑΤ!
- NO** KONTROLER FUNKSJONENE MED EN TESTER MED BELASTNING ELLER LYSPÆRER MED RIKTIG WATTVERDI!
- PL** SPRAWDŹ FUNKCJE UŻYWAJĄC SKRZYŃKI TESTOWEJ Z OBCIĄŻENIEM LUB PODŁĄCZONYMI ŻARÓWKAMI O ODPOWIEDNIEJ MOCY!

12

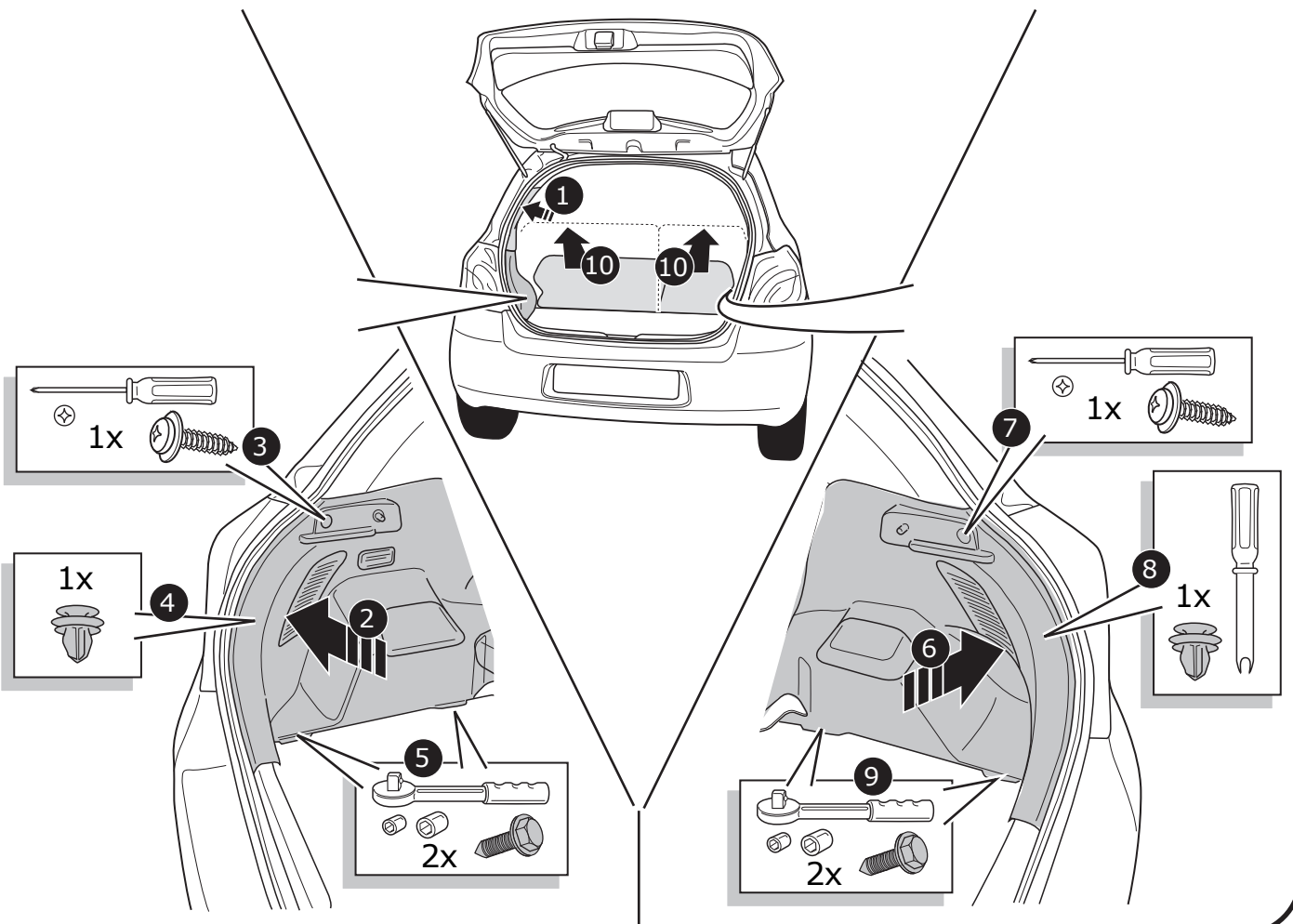



13

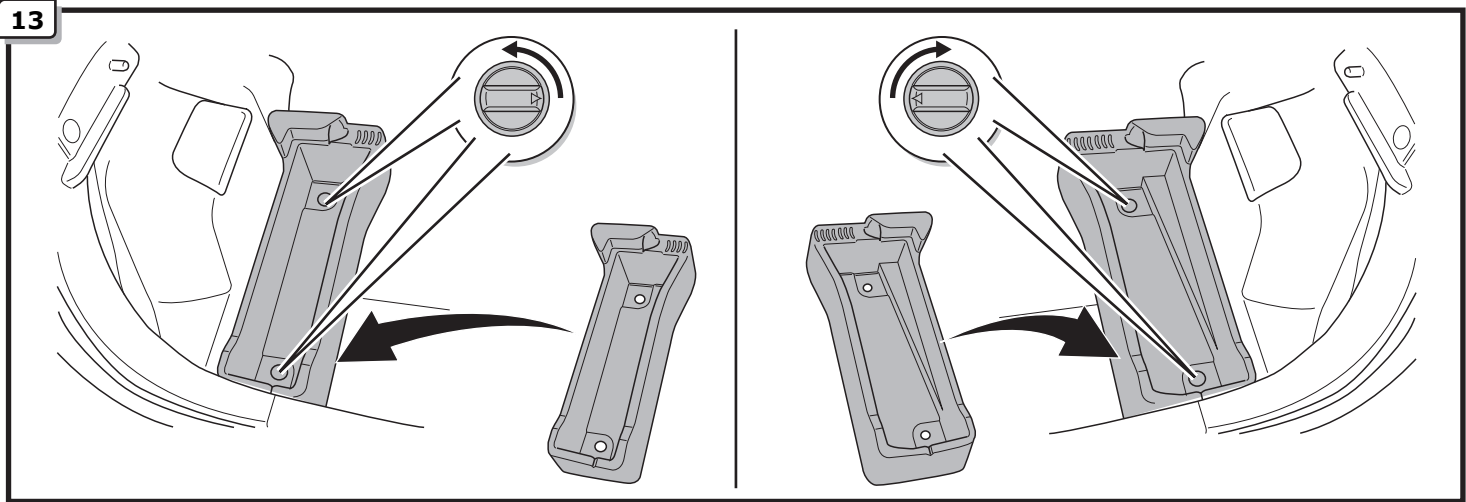



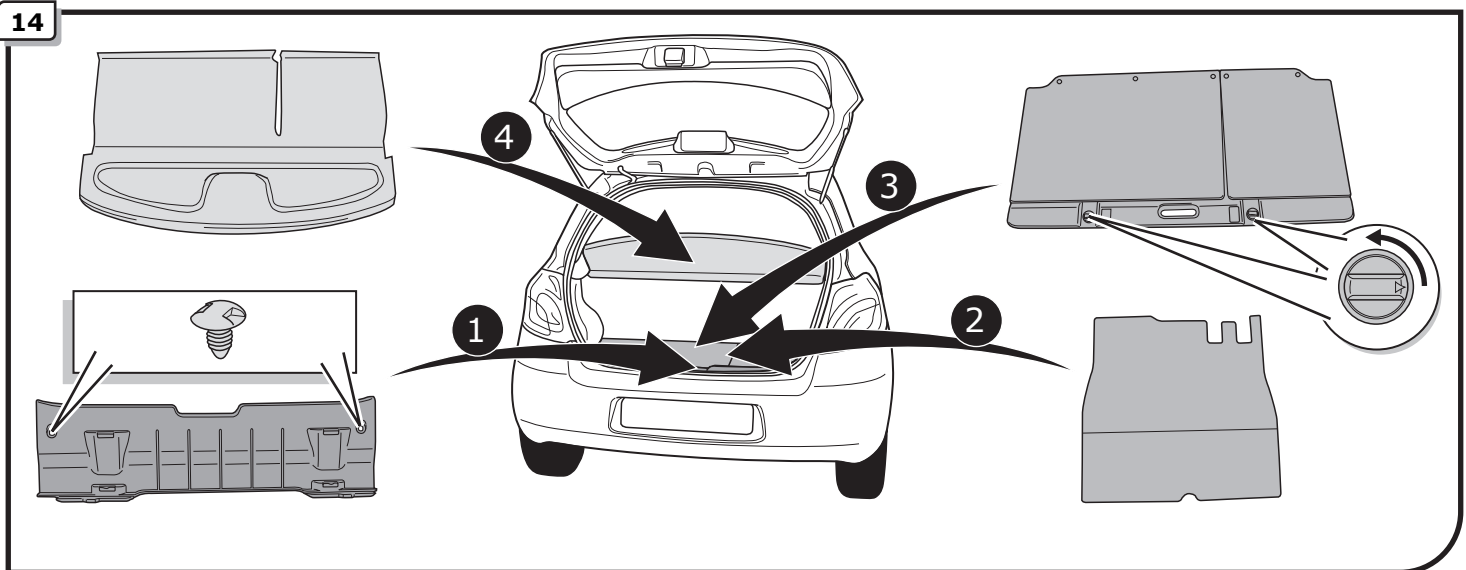





14



**INFO**

- |  |                                    |
|--|------------------------------------|
| <b>DE</b> Anschluss Steckdose            | <b>CZ</b> Objímkový konektor       |
| <b>FR</b> Connection de la prise         | <b>DK</b> Stikdåse forbindelse     |
| <b>NL</b> Contactdoos aansluiting        | <b>FI</b> Pistorasia liitäntä      |
| <b>GB</b> Socket connection              | <b>GR</b> Υποδοχή σύνδεσης         |
| <b>ES</b> Conexión de la caja de enchufe | <b>NO</b> Tilkobling koblingsboks  |
| <b>IT</b> Allaccio zoccolo               | <b>PL</b> Połączenie przez gniazdo |
| <b>SE</b> Anslutning kontaktdosa         |                                    |

DIN/ISO 1724			 1-8					
	1/L	2	3/31	4/R	5/58-R	6/54	7/58-L	8
<b>Pmax</b>	21W	2x21W		21W	52W	3x21W	52W	
<b>DE</b>	Gelb	Blau	Weiß	Grün	Braun	Rot	Schwarz	Grau
<b>FR</b>	Jaune	Bleu	Blanc	Vert	Marron	Rouge	Noir	Gris
<b>NL</b>	Geel	Blauw	Wit	Groen	Bruin	Rood	Zwart	Grijs
<b>GB</b>	Yellow	Blue	White	Green	Brown	Red	Black	Grey
<b>ES</b>	Amarillo	Azul	Blanco	Verde	Marrón	Rojo	Negro	Gris
<b>IT</b>	Giallo	Blu	Bianco	Verde	Marrone	Rosso	Nero	Grigio
<b>SE</b>	Gul	Blå	Vit	Grön	Brun	Röd	Svart	Grå
<b>CZ</b>	Žlutá	Modrá	Bílá	Zelená	Hnědá	Červená	Černá	Šedá
<b>DK</b>	Gul	Blå	Hvid	Grøn	Brun	Rød	Sort	Grå
<b>FI</b>	Keltainen	Sininen	Valkoinen	Vihreä	Ruskea	Punainen	Musta	Harmaa
<b>GR</b>	Κίτρινο	Μπλε	Λευκό	Πράσινο	Καφέ	Κόκκινο	Μαύρο	Γκρι
<b>NO</b>	Gul	Blå	Hvit	Grønn	Brun	Rød	Svart	Grå
<b>PL</b>	Żółty	Niebieski	Biały	Zielony	Brązowy	Czerwony	Czarny	Szary